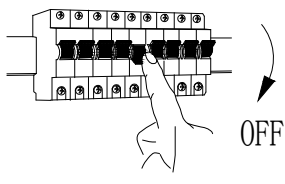
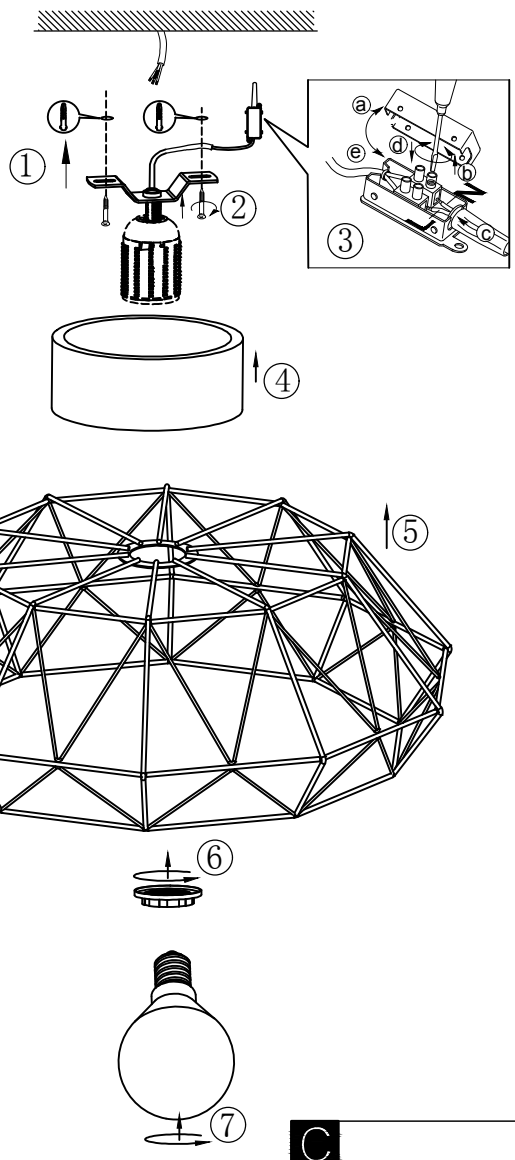
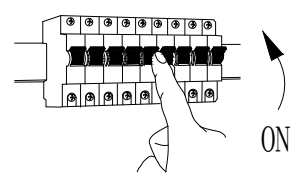

A**B****C**

BLA43363
www.eglo.com